

SHF SERIES

4 WAY REVERSING VALVE

SHF series four-way reversing valves are applicable for heat pump systems such as central, unitary and room air conditioners to realize switching between cooling mode and heating mode by changing the flow path of refrigerant. SHF valves can be installed in system using flammable refrigerants HFO (categories A2 and A2L*), and Hydrocarbons HC (category A3*).

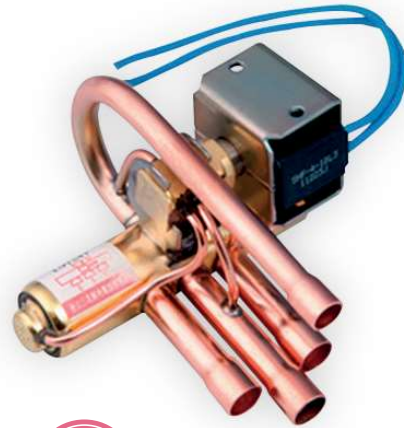

FEATURES

- WIDE APPLICATION RANGE
- SUITABLE FOR COOLING CAPACITIES FROM 3.5 TO 409KW (R290, CONDITION 2, $\Delta P=0.1\text{BAR}$)
- SEVERAL DESIGNS AVAILABLE
- CERTIFIED ACCORDING PED CAT.II BY TUV RHEINLAND

GENERAL SPECIFICATIONS

- Applicable for all common HCFC, HFC, HFO, HC refrigerants such as: R22, R134a, R404A, R407A/C/F, R410A, R507A, R448A, R449A, R450A, R452A, R513A, R32, R1234yf, R1234ze, R454A/B/C, R455A, R290, R1270, R600a
- Medium temperature TS min./max.: -30°C / $+135^{\circ}\text{C}$
- Ambient temperature min./max.: -30°C / $+50^{\circ}\text{C}$
- Relative humidity: 0 to 95% RH
- Max. operating pressure PS ≥ 4.5 MPa (45 bar)
- Installation position:
 - Coil upwards or with body axis in horizontal alignment
 - Flow direction according to installation instruction
- Certifications: UL/CSA3) and declaration according to LVD and PED

Note: *according ANSI-ASHRAE 34-2016 and EN-378-1 ANNE EN 378-1:2016 Annex E

SHF SERIES

4 WAY REVERSING VALVE



TABLE 1: MODELS SUITABLE FOR USAGE ON SYSTEM WITH VARIABLE SPEED (INVERTER)

General Characteristics											
Valve Model	Product Number	Type of System [Variable or Fixed Speed]	Ø Port	Kv	Connections ODF		MOP	OPD		PED Category	
					ØD	ØE/S/C		Max.	Min.	Fluid	Fluid
			[mm]	[m³/h]	[inch]	[inch]	[MPa]	[MPa]	[MPa]	Group 2	Group 1
SHF(L)-3H-12U-52	10180953202	Variable & Fixed	7,4	1,5	1/4	5/16	4,7	4	0,1	4,3	4,3
SHF(L)-4H-23U-52	10180952502	Variable & Fixed	8	1,6	5/16	3/8	4,7	4	0,1	4,3	4,3
SHF(L)-7H-34U-52	10180952602	Variable & Fixed	11,1	2,9	3/8	1/2	4,7	4	0,1	4,3	4,3
SHF(L)-7H-34-52	10180953302	Variable & Fixed	11,1	2,9	3/8	1/2	4,7	4	0,1	4,3	4,3
SHF(L)-7H-35-52	10180950002	Variable & Fixed	11,1	2,9	3/8	5/8	4,7	4	0,1	4,3	4,3
SHF(L)-11H-34U-52	10180953402	Variable & Fixed	11,5	4,5	3/8	1/2	4,7	4	0,1	4,3	4,3
SHF(L)-11H-35U-52	10180952402	Variable & Fixed	11,5	4,5	3/8	5/8	4,7	4	0,1	4,3	4,3
SHF(L)-11H-45D1-52	10180950102	Variable & Fixed	11,5	4,5	1/2	5/8	4,7	4	0,1	4,3	4,3
SHF(L)-11H-46D1-52	10180953502	Variable & Fixed	11,5	4,5	1/2	3/4	4,7	4	0,1	4,3	4,3
SHF-14A-46	10325030102	Variable & Fixed	13,5	6,6	1/2	3/4	4,7	4	0,1	4,3	4,3
SHF-20D-46-02	10325051602	Variable	17,2	9,5	1/2	3/4	4,7	4	0,1	4,3	4,3
SHF-20D-47-02	10325055702	Variable	17,2	9,9	1/2	7/8	4,7	4	0,1	4,3	4,3
SHF-20D-57-02	10325060202	Variable	17,2	9,9	5/8	7/8	4,7	4	0,1	4,3	4,3
SHF-20D-67-02	10325060102	Variable	17,2	9,9	3/4	7/8	4,7	4	0,1	4,3	4,3
SHF-35B-47-04	10325058802	Variable	20	14,7	1/2	7/8	4,7	4	0,1	4,3	4,3
SHF-35B-57-04	10325059002	Variable	20	14,7	5/8	7/8	4,7	4	0,1	4,3	4,3
SHF-35B-59-04	10325059102	Variable	20	14,7	5/8	1 1/8	4,7	4	0,1	4,3	4,3
SHF-35B-67-04	10325050802	Variable	20	14,7	3/4	7/8	4,7	4	0,1	4,3	4,3
SHF-35B-69-04	10325058502	Variable	20,9	14,7	3/4	1 1/8	4,7	4	0,1	4,3	4,3
SHF-35B-79-04	10325058302	Variable	20,9	14,7	7/8	1 1/8	4,7	4	0,1	4,3	4,3
SHF-50A-79	10325059702	Variable & Fixed	22,8	18,3	7/8	1 1/8	4,5	4	0,1	4,3	4,3
SHF(L)-70-810-20	10325049401	Variable	28,6	28,5	1	1 1/4	4,5	4	0,15	4,3	II
SHF(L)-70-810-21	10325048501	Variable	28,6	28,5	1	1 1/4	4,5	4	0,15	4,3	II
SHF(L)-70-911-20	10325048701	Variable	28,6	28,5	1 1/8	1 3/8	4,5	4	0,15	4,3	II
SHF(L)-70-911-21	10325048901	Variable	28,6	28,5	1 1/8	1 3/8	4,5	4	0,15	4,3	II
SHF(L)-70-913-25	10325049301	Variable	28,6	28,5	1 1/8	1 5/8	4,5	4	0,15	I	II
SHF(L)-70-913-23	10325049101	Variable	28,6	28,5	1 1/8	1 5/8	4,5	4	0,15	I	II
SHF(L)-100-911	10325054502	Variable & Fixed	34,8	40,5	1 1/8	1 3/8	4,5	4	0,15	I	II
SHF(L)-100-911-01	10325054602	Variable & Fixed	34,8	40,5	1 1/8	1 3/8	4,5	4	0,15	I	II
SHF(L)-100-913	10325054302	Variable & Fixed	34,8	40,5	1 1/8	1 5/8	4,5	4	0,15	I	II
SHF(L)-100-913-01	10325054402	Variable & Fixed	34,8	40,5	1 1/8	1 5/8	4,5	4	0,15	I	II
SHF(L)-100-1012	10325053702	Variable & Fixed	34,8	40,5	1 1/4	1 1/2	4,5	4	0,15	I	II
SHF(L)-100-1012-01	10325054002	Variable & Fixed	34,8	40,5	1 1/4	1 1/2	4,5	4	0,15	I	II
SHF(L)-100-1013	10325053902	Variable & Fixed	34,8	40,5	1 1/4	1 5/8	4,5	4	0,15	I	II
SHF(L)-100-1013-01	10325054202	Variable & Fixed	34,8	40,5	1 1/4	1 5/8	4,5	4	0,15	I	II

SHF SERIES

4 WAY REVERSING VALVE

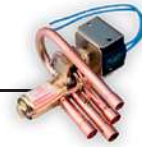

TABLE 1: MODELS SUITABLE FOR USAGE ON SYSTEM WITH VARIABLE SPEED (INVERTER)

General Characteristics											
Valve Model	Product Number	Type of System [Variable or Fixed Speed]	Ø Port	Kv	Connections ODF		MOP	OPD		PED Category	
					ØD	ØE/S/C		Max.	Min.	Fluid	Fluid
			[mm]	[m³/h]	[inch]	[inch]	[MPa]	[MPa]	[MPa]	Group 2	Group 1
SHF(L)-140-1113	10325053402	Variable & Fixed	41	58,4	1 3/8	1 5/8	4,5	4	0,15	I	II
SHF(L)-140-1213	10325053502	Variable & Fixed	41	58,4	1 1/2	1 5/8	4,5	4	0,15	I	II
SHF(L)-140-1214	10325053302	Variable & Fixed	41	58,4	1 1/2	1 3/4	4,5	4	0,15	I	II
SHF(L)-140-1313	10325053602	Variable & Fixed	41	58,4	1 5/8	1 5/8	4,5	4	0,15	I	II
SHF(L)-175-1217	10325054902	Variable & Fixed	46,4	70,5	1 1/2	2 1/8	4,5	4	0,15	I	II
SHF(L)-175-1317	10325055002	Variable & Fixed	46,4	70,5	1 5/8	2 1/8	4,5	4	0,15	I	II
SHF(L)-210-1321	10325055102	Variable & Fixed	50	84,4	1 5/8	2 5/8	4,5	4	0,15	I	II
SHF(L)-350-1721	10325055202	Variable & Fixed	59	138,4	2 1/8	2 5/8	4,5	4	0,15	I	II
SHF(L)-420-2125	10325055302	Variable & Fixed	69	177	2 5/8	3 1/8	4,5	4	0,15	I	II

TABLE 2: MODELS OPTIMIZED FOR USAGE ON SYSTEM WITH FIXED SPEED (ON/OFF COMPRESSORS)

General Characteristics											
Valve Model	Product Number	Type of System [Variable or Fixed Speed]	Ø Port	Kv	Connections ODF		MOP	OPD		PED Category	
					ØD	ØE/S/C		Max.	Min.	Fluid	Fluid
			[mm]	[m³/h]	[inch]	[inch]	[MPa]	[MPa]	[MPa]	Group 2	Group 1
SHF-20D-46-01	10325051502	Fixed	17,2	9,5	1/2	3/4	4,7	4	0,1	4,3	4,3
SHF-20D-47-01	10325057402	Fixed	17,2	9,9	1/2	7/8	4,7	4	0,1	4,3	4,3
SHF-20D-57-01	10325057302	Fixed	17,2	9,9	5/8	7/8	4,7	4	0,1	4,3	4,3
SHF-20D-67-01	10325050102	Fixed	17,2	9,9	3/4	7/8	4,7	4	0,1	4,3	4,3
SHF-35B-47-01	10325058702	Fixed	20	14,7	1/2	7/8	4,7	4	0,1	4,3	4,3
SHF-35B-57-01	10325058902	Fixed	20	14,7	5/8	7/8	4,7	4	0,1	4,3	4,3
SHF-35B-59-01	10325050202	Fixed	20	14,7	5/8	1 1/8	4,7	4	0,1	4,3	4,3
SHF-35B-67-01	10325050702	Fixed	20	14,7	3/4	7/8	4,7	4	0,1	4,3	4,3
SHF-35B-69-01	10325058402	Fixed	20,9	14,7	3/4	1 1/8	4,7	4	0,1	4,3	4,3
SHF-35B-79-01	10325052702	Fixed	20,9	14,7	7/8	1 1/8	4,7	4	0,1	4,3	4,3
SHF(L)-70-810-10	10325048302	Fixed	28,6	28,5	1	1 1/4	4,5	4	0,15	4,3	II
SHF(L)-70-810-11	10325048402	Fixed	28,6	28,5	1	1 1/4	4,5	4	0,15	4,3	II
SHF(L)-70-911-10	10325048602	Fixed	28,6	28,5	1 1/8	1 3/8	4,5	4	0,15	4,3	II
SHF(L)-70-911-11	10325048802	Fixed	28,6	28,5	1 1/8	1 3/8	4,5	4	0,15	4,3	II
SHF(L)-70-913-15	10325049202	Fixed	28,6	28,5	1 1/8	1 5/8	4,5	4	0,15	I	II
SHF(L)-70-913-13	10325049002	Fixed	28,6	28,5	1 1/8	1 5/8	4,5	4	0,15	I	II

NOMINAL OPERATING CONDITIONS

Nominal Operating Conditions	Condition 1	Condition 2
Condensing Temperature t_c	38°C	54,4°C
Evaporating Temperature t_e	5°C	7,2°C
Superheat Δt_{sc}	5K	5K
Subcooling Δt_{sr}	0K	5K

Notes for Capacity Selection Tables: 1) Pressure drop is valid for flow on low pressure side (from ØC to ØS or from ØE to ØS)

SHF SERIES

4 WAY REVERSING VALVE

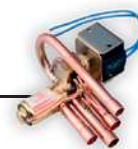

1) CAPACITY TABLES – NOMINAL WORKING CONDITION 1

Capacity Selection Table								
Valve Size	Nominal Cooling Capacity (condition 1)							
	R290		R1270		R600a		R32	
	$\Delta P:$ 0,1 bar	$\Delta P:$ 0,2 bar	$\Delta P:$ 0,1 bar	$\Delta P:$ 0,2 bar	$\Delta P:$ 0,1 bar	$\Delta P:$ 0,2 bar	$\Delta P:$ 0,1 bar	$\Delta P:$ 0,2 bar
	[kW]	[kW]	[kW]	[kW]	[kW]	[kW]	[kW]	[kW]
SHF(L)-3H	4,1	5,8	4,5	6,4	2,6	3,6	5,2	7,4
SHF(L)-4H	4,4	6,2	4,8	6,8	2,7	3,9	5,6	7,9
SHF(L)-7H	7,9	11,2	8,7	12,4	5,0	7,0	10,1	14,3
SHF(L)-11H	12,3	17,4	13,6	19,2	7,7	10,9	15,7	22,2
SHF-14A-46	18,0	25,5	19,9	28,1	11,3	16,0	23,0	32,5
SHF-20D-46	25,9	36,7	28,6	40,5	16,3	23,0	33,1	48,8
SHF-20D-xx	25,9	36,7	28,6	40,5	16,3	23,0	33,1	46,8
SHF-35B	40,1	56,8	44,3	62,6	25,2	35,6	51,3	72,5
SHF-50A-79	50,0	70,6	55,1	77,9	31,3	44,3	63,8	90,2
SHF(L)-70	77,8	110,0	85,8	121,3	48,8	69,0	99,4	140,5
SHF(L)-100	110,6	156,4	121,9	172,4	69,3	98,0	141,2	199,7
SHF(L)-140	159,4	225,5	175,8	248,6	99,9	141,3	203,6	287,9
SHF(L)-175	192,5	272,2	212,2	300,2	120,6	170,6	245,8	347,6
SHF(L)-210	230,4	325,8	254,1	359,3	144,4	204,2	294,2	416,1
SHF(L)-350	377,8	534,3	416,6	589,2	236,8	334,9	482,5	682,3
SHF(L)-420	483,2	683,3	532,9	753,6	302,8	428,2	617,1	872,6

Capacity Selection Table								
Valve Size	Nominal Cooling Capacity (condition 1)							
	R1234yf		R1234ze		R454B		R455A	
	$\Delta P:$ 0,1 bar	$\Delta P:$ 0,2 bar	$\Delta P:$ 0,1 bar	$\Delta P:$ 0,2 bar	$\Delta P:$ 0,1 bar	$\Delta P:$ 0,2 bar	$\Delta P:$ 0,1 bar	$\Delta P:$ 0,2 bar
	[kW]	[kW]	[kW]	[kW]	[kW]	[kW]	[kW]	[kW]
SHF(L)-3H	2,2	3,2	2,2	3,0	4,4	6,2	2,9	4,1
SHF(L)-4H	2,4	3,4	2,3	3,2	4,7	6,6	3,1	4,4
SHF(L)-7H	4,3	6,1	4,2	5,9	8,4	11,9	5,6	8,0
SHF(L)-11H	6,7	9,5	6,5	9,1	13,1	18,5	8,7	12,4
SHF-14A-46	9,8	13,9	9,5	13,4	19,2	27,1	12,8	18,1
SHF-20D-46	14,2	20,0	13,6	19,3	27,6	39,1	18,4	26,1
SHF-20D-xx	14,2	20,0	13,6	19,3	27,6	39,1	18,4	26,1
SHF-35B	21,9	31,0	21,1	29,8	42,7	60,4	28,5	40,3
SHF-50A-79	27,3	38,5	26,2	37,1	53,2	75,2	35,5	50,2
SHF(L)-70	42,4	60,0	40,9	57,8	82,9	117,2	55,3	78,2
SHF(L)-100	60,3	85,3	58,1	82,1	117,7	166,5	78,6	111,1
SHF(L)-140	87,0	123,0	83,7	118,4	169,8	240,1	113,3	160,2
SHF(L)-175	105,0	148,5	101,1	143,0	205,0	289,8	136,8	193,4
SHF(L)-210	125,7	177,7	121,0	171,1	245,4	347,0	163,7	231,6
SHF(L)-350	206,1	291,5	198,4	280,6	402,3	569,0	268,5	379,7
SHF(L)-420	263,6	372,7	253,8	358,9	514,6	727,7	343,4	485,7

SHF SERIES

4 WAY REVERSING VALVE

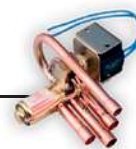

Capacity Selection Table								
Valve Size	Nominal Cooling Capacity (condition 2)							
	R290		R1270		R600a		R32	
	ΔP : 0,1 bar	ΔP : 0,2 bar	ΔP : 0,1 bar	ΔP : 0,2 bar	ΔP : 0,1 bar	ΔP : 0,2 bar	ΔP : 0,1 bar	ΔP : 0,2 bar
	[kW]	[kW]	[kW]	[kW]	[kW]	[kW]	[kW]	[kW]
SHF(L)-3H	3,8	5,3	4,2	5,9	2,4	3,4	4,9	6,9
SHF(L)-4H	4,0	5,7	4,4	6,3	2,6	3,6	5,2	7,4
SHF(L)-7H	7,3	10,3	8,1	11,4	4,7	6,6	9,5	13,4
SHF(L)-11H	11,3	16,0	12,5	17,7	7,2	10,2	14,7	20,8
SHF-14A-46	16,6	23,5	18,3	25,9	10,6	15,0	21,6	30,5
SHF-20D-46	23,9	33,8	26,4	37,3	15,2	21,6	31,0	43,9
SHF-20D-xx	23,9	33,8	26,4	37,3	15,2	21,6	31,0	43,9
SHF-35B	37,0	52,3	40,8	57,7	23,6	33,4	48,0	67,9
SHF-50A-79	46,0	65,1	50,8	71,9	29,4	41,5	59,8	84,6
SHF(L)-70	71,7	101,3	79,2	111,9	45,7	64,7	93,1	131,7
SHF(L)-100	101,8	144,0	112,5	159,1	65,0	91,9	132,3	187,2
SHF(L)-140	146,8	207,6	162,2	229,4	93,7	132,5	190,8	269,9
SHF(L)-175	177,2	250,6	195,8	276,9	113,1	160,0	230,4	325,8
SHF(L)-210	212,2	300,1	234,4	331,5	135,4	191,5	275,8	390,0
SHF(L)-350	347,9	492,0	384,4	543,6	222,1	314,0	452,3	639,6
SHF(L)-420	445,0	629,3	491,6	695,2	284,0	401,6	578,4	818,0

Capacity Selection Table								
Valve Size	Nominal Cooling Capacity (condition 2)							
	R1234yf		R1234ze		R454B		R455A	
	ΔP : 0,1 bar	ΔP : 0,2 bar	ΔP : 0,1 bar	ΔP : 0,2 bar	ΔP : 0,1 bar	ΔP : 0,2 bar	ΔP : 0,1 bar	ΔP : 0,2 bar
	[kW]	[kW]	[kW]	[kW]	[kW]	[kW]	[kW]	[kW]
SHF(L)-3H	2,1	2,8	2,0	2,8	4,0	5,7	2,6	3,7
SHF(L)-4H	2,2	3,0	2,1	3,0	4,3	6,1	2,8	4,0
SHF(L)-7H	3,9	5,5	3,8	5,4	7,8	11,0	5,1	7,2
SHF(L)-11H	6,0	8,5	6,0	8,4	12,1	17,1	7,9	11,2
SHF-14A-46	8,9	12,5	8,8	12,4	17,7	25,1	11,6	16,4
SHF-20D-46	12,8	18,0	12,6	17,8	25,5	36,1	16,7	23,6
SHF-20D-xx	12,8	18,0	12,6	17,8	25,5	36,1	16,7	23,6
SHF-35B	19,7	27,9	19,5	27,6	39,5	55,9	25,8	36,5
SHF-50A-79	24,6	34,7	24,3	34,4	49,2	69,5	32,2	45,5
SHF(L)-70	38,3	54,1	37,8	53,5	76,6	108,3	50,1	70,8
SHF(L)-100	54,4	76,9	53,8	76,0	108,8	153,9	71,2	100,6
SHF(L)-140	78,4	110,9	77,5	109,6	156,9	221,9	102,6	145,1
SHF(L)-175	94,6	133,9	93,6	132,4	189,5	267,9	123,9	175,2
SHF(L)-210	113,3	160,2	112,0	158,5	226,8	320,7	148,3	209,7
SHF(L)-350	185,8	262,8	183,7	259,8	371,9	526,0	243,2	343,9
SHF(L)-420	237,6	336,1	235,0	332,3	475,6	672,7	311,0	439,8

SHF SERIES
4 WAY REVERSING VALVE

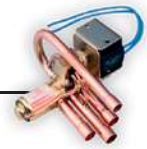

DIMENSIONS - VALVES

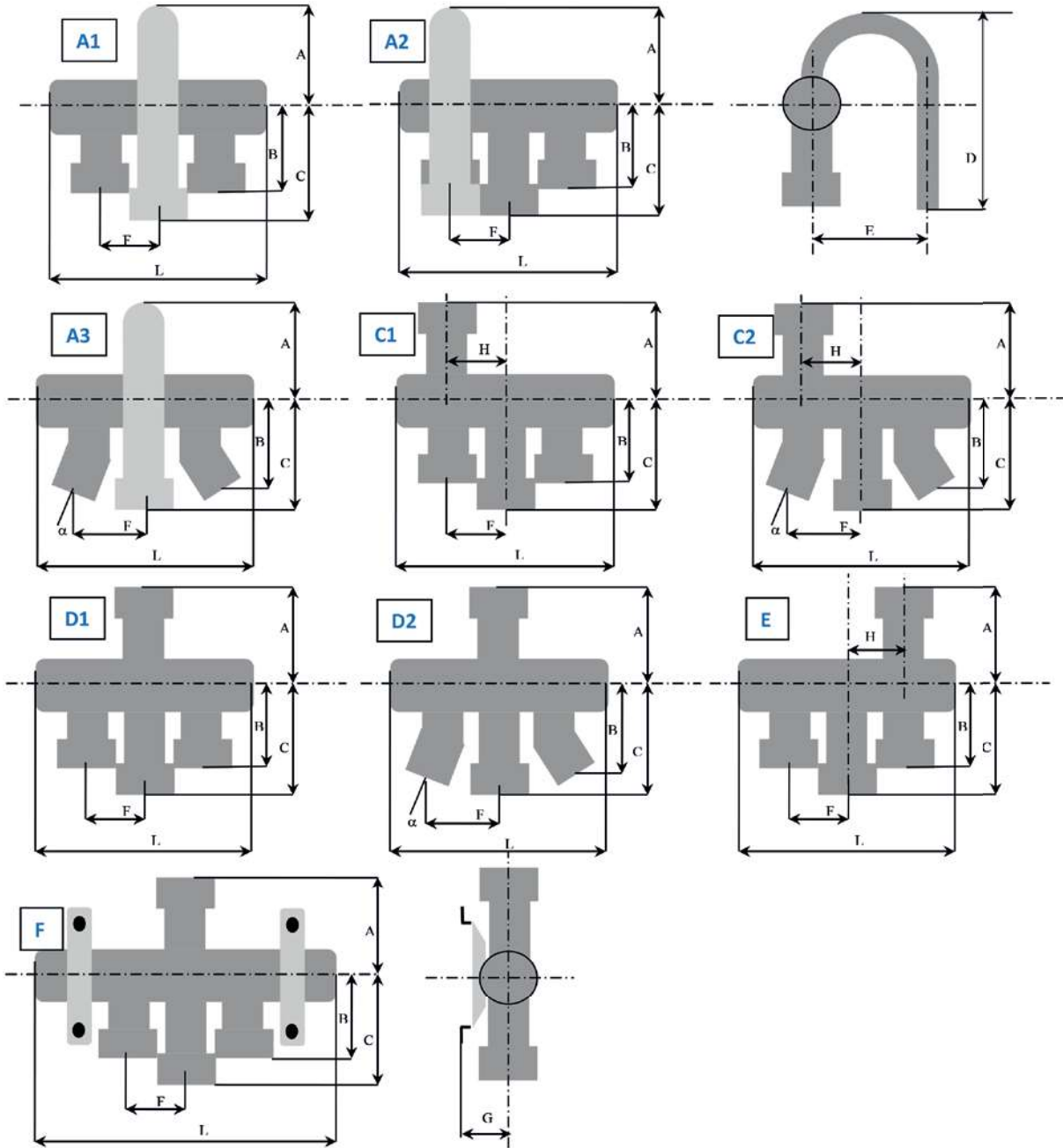

SHF SERIES

4 WAY REVERSING VALVE

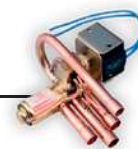
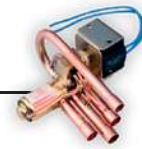

TABLE 3: MODELS SUITABLE FOR USAGE ON SYSTEM WITH VARIABLE SPEED (INVERTER)

Dimensions - Valves												
Valve Model	Valve Style	L	A	B	C	D	E	F	G	H	Angle α	Weight
		[mm]	[mm]	[mm]	[mm]	[mm]	[mm]	[mm]	[mm]	[mm]	[°]	[kg]
SHF(L)-3H-12U-51	A1	88,2	38,5	38	50	88,5	43	11	-	-	0	0,2
SHF(L)-4H-23U-51	A1	94,4	43	50	62	105	43	12	-	-	0	0,2
SHF(L)-7H-34U-51	A1	113	52	59	71	119	52	16	-	-	0	0,3
SHF(L)-7H-34-51	D1	113	52	59	71	-	-	16	-	-	0	0,3
SHF(L)-7H-35-51	D2	113	52	57	72	-	-	23,5	-	16	0	0,3
SHF(L)-11H-34U-51	A1	115,5	51	59	71	119	52	16	-	-	0	0,3
SHF(L)-11H-35U-51	A3	115,5	51	57	71	119	52	23,5	-	-	15	0,3
SHF(L)-11H-45D1-51	C2	117	52	62	87	-	-	25	-	16	15	0,32
SHF(L)-11H-46D1-51	C2	117	52	82	87	-	-	32,5	-	16	20	0,35
SHF-14A-46	D1	163	67	83	95	-	-	23,8	-	-	0	0,72
SHF-20D-46-02	D1	183,6	67	83	95	-	-	28,6	-	-	0	0,75
SHF-20D-47-02	D1	183,6	67	83	95	-	-	28,6	-	-	0	0,75
SHF-20D-57-02	D1	183,6	67	83	95	-	-	28,6	-	-	0	0,75
SHF-20D-67-02	D1	183,6	67	83	95	-	-	28,6	-	-	0	0,75
SHF-35B-47-04	D1	212,2	82	87	100	-	-	33	-	-	0	1,3
SHF-35B-57-04	D1	212,2	82	87	100	-	-	33	-	-	0	1,3
SHF-35B-59-04	D1	212,2	82	87	100	-	-	33	-	-	0	1,3
SHF-35B-67-04	D1	212,2	82	87	100	-	-	33	-	-	0	1,3
SHF-35B-69-04	D1	212,2	82	87	100	-	-	33	-	-	0	1,3
SHF-35B-79-04	D1	212,2	82	87	100	-	-	33	-	-	0	1,3
SHF-50A-79	D1	217	91	96	128	-	-	33	-	-	0	2,1
SHF(L)-70-810-20	D1	303	111	117	131	-	-	46	-	-	0	3
SHF(L)-70-810-21	F	303	111	117	154	-	-	46	58	-	0	3
SHF(L)-70-911-20	D1	303	111	117	154	-	-	46	-	-	0	3
SHF(L)-70-911-21	F	321	111	117	131	-	-	49	58	-	0	3,5
SHF(L)-70-913-25	D1	321	111	117	131	-	-	49	-	-	0	3,5
SHF(L)-70-913-23	F	321	111	117	131	-	-	49	58	-	0	3,5
SHF(L)-100-911	D1	321	111	117	131	-	-	49	-	-	0	3,5
SHF(L)-100-911-01	F	303	111	117	131	-	-	46	58	-	0	3
SHF(L)-100-913	D1	303	111	117	154	-	-	46	-	-	0	3
SHF(L)-100-913-01	F	303	111	117	154	-	-	46	58	-	0	3
SHF(L)-100-1012	D1	321	111	117	131	-	-	49	-	-	0	3,5
SHF(L)-100-1012-01	F	321	111	117	131	-	-	49	58	-	0	3,5
SHF(L)-100-1013	D1	321	111	117	131	-	-	49	-	-	0	3,5
SHF(L)-100-1013-01	F	321	111	117	131	-	-	49	58	-	0	3,5
SHF(L)-140-1113	F	390	135,6	148,7	168,7	-	-	58	63	-	0	7,2
SHF(L)-140-1213	F	390	135,6	148,7	168,7	-	-	58	63	-	0	7,2
SHF(L)-140-1214	F	390	135,6	148,7	168,7	-	-	58	63	-	0	7,2
SHF(L)-140-1313	F	390	135,6	148,7	168,7	-	-	58	63	-	0	7,2
SHF(L)-175-1217	F	390	135,6	148,7	198	-	-	58	63	-	0	7,6
SHF(L)-175-1317	F	390	135,6	148,7	198	-	-	58	63	-	0	7,6
SHF(L)-210-1321	F	452	135,6	148,7	198	-	-	71,5	63	-	0	8,7
SHF(L)-350-1721	F	531	176,5	184	240	-	-	75	82,5	-	0	22
SHF(L)-420-2125	F	611,7	176,5	184	240	-	-	93	82,5	-	0	26

SHF SERIES
4 WAY REVERSING VALVE

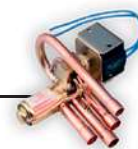

**TABLE 4: MODELS OPTIMIZED FOR USAGE ON SYSTEM WITH FIXED SPEED
(ON/OFF COMPRESSORS)**

Dimensions - Valves												
Valve Model	Valve Style	L	A	B	C	D	E	F	G	H	Angle α	Weight
		[mm]	[mm]	[mm]	[mm]	[mm]	[mm]	[mm]	[mm]	[mm]	[°]	[kg]
SHF-20D-46-01	D1	183,6	67	83	95	-	-	28,6	-	-	0	0,75
SHF-20D-47-01	D1	183,6	67	83	95	-	-	28,6	-	-	0	0,75
SHF-20D-57-01	D1	183,6	67	83	95	-	-	28,6	-	-	0	0,75
SHF-20D-67-01	D1	183,6	67	83	95	-	-	28,6	-	-	0	0,75
SHF-35B-47-01	D1	212,2	82	87	100	-	-	33	-	-	0	1,3
SHF-35B-57-01	D1	212,2	82	87	100	-	-	33	-	-	0	1,3
SHF-35B-59-01	D1	212,2	82	87	100	-	-	33	-	-	0	1,3
SHF-35B-67-01	D1	212,2	82	87	100	-	-	33	-	-	0	1,3
SHF-35B-69-01	D1	212,2	82	87	100	-	-	33	-	-	0	1,3
SHF-35B-79-01	D1	212,2	82	87	100	-	-	33	-	-	0	1,3
SHF(L)-70-810-10	D1	303	111	117	131	-	-	46	-	-	0	3
SHF(L)-70-810-11	D1	303	111	117	131	-	-	46	-	-	0	3
SHF(L)-70-911-10	D1	303	111	117	154	-	-	46	-	-	0	3
SHF(L)-70-911-11	F	321	111	117	131	-	-	49	58	-	0	3,5
SHF(L)-70-913-15	D1	321	111	117	131	-	-	49	-	-	0	3,5
SHF(L)-70-913-13	F	321	111	117	131	-	-	49	58	-	0	3,5

SHF SERIES

4 WAY REVERSING VALVE



Coil Characteristics															
Coil Model ¹⁾	Winding Code	Part Number	Electrical Function/Connection Type	Cable Length	Power Supply	Rated Voltage	Power Consumption			Protection Class	Insulat. Class	Max. Op. Temp.			
							AC	AC	DC						
							50Hz	60Hz							
[mm]	[-]	[V]	[W]	[W]	[W]	[-]	[-]	[°C]							
SQ-A25 22G-00 0001	SHF-4-10L3	10805029102	Lead Wires	500	AC	220-240	4,5	3,5	-	IP54	B ²⁾	130			
SQ-A25 200-00 0001	SHF-4-10L2	10805027002	Lead Wires	500	AC	200	4,5	3,5	-						
SQ-A25 100-00 0001	SHF-4-10L1	10805023602	Lead Wires	500	AC	100	4,5	3,5	-						
SQ-A25 11A-00 0001	SHF-4-10L4	10805150302	Lead Wires	500	AC	110-120	4,5	3,5	-						
SQ-A25 024-00 0001	SHF-4-10L5	10805227602	Lead Wires	500	AC	24	4,5	3,5	-						
SQ-A25 26H-00 0001	SHF-4-10L6	10805231902	Lead Wires	500	AC	265-277	4,5	3,5	-						
SQ-A25 22G-00 0870	SHF-4-10L3	10805240702	Lead Wires	1500	AC	220-240	4,5	3,5	-						
SQ-A25 11A-00 0840	SHF-4-10L4	10805240802	Lead Wires	1500	AC	110-120	4,5	3,5	-						
SQ-A25 024-00 0161	SHF-4-10L5	10805023002	Lead Wires	1500	AC	24	4,5	3,5	-						
SQ-A47 22G-00 0001	SHF-4-10FA5	10805263402	Spade (Faston) ³⁾	-	AC	220-240	6	5	-				IP00	F ²⁾	155
SQ-A47 220-00 0001	SHF-4-10FA1	10805273402	Spade (Faston) ³⁾	-	AC	220	6	5	-						
SQ-A47 11B-00 0001	SHF-4-10FA2	10805273302	Spade (Faston) ³⁾	-	AC	120	6	5	-						
SQ-A47 10A-00 0001	SHF-4-10FA3	10805268702	Spade (Faston) ³⁾	-	AC	100-110	6	5	-						
SQ-A47 024-00 0001	SHF-4-10FA4	10805263302	Spade (Faston) ³⁾	-	AC	24	6	5	-						
SQ-A47 26H-00 0001	SHF-4-10FA6	10805273502	Spade (Faston) ³⁾	-	AC	265-277	6	5	-						
SQ-D44 012-00 0001	SHF-4-10FA8	10805231802	Spade (Faston) ³⁾	-	DC	12	-	-	10						
SQ-D44 024-00 0001	SHF-4-10FA9	10805070102	Spade (Faston) ³⁾	-	DC	24	-	-	11						
SQ-A27 100-00 0001	-	10805063202	Bi-stable/Lead W.	500	AC	100	18	18	-	IP54	B ²⁾	130			
SQ-A27 200-00 0001	-	10805063802	Bi-stable/Lead W.	500	AC	200	18	18	-						
SQ-A27 20K-00 0001	-	10805222902	Bi-stable/Lead W.	500	AC	220-240	18	18	-						
SQ-D27 012-00 0001	-	10805069302	Bi-stable/Lead W.	500	DC	12	-	-	20						

- Note:**
- 1) Every coil is applicable to all above specified valve models
 - 2) Max ambient temperature up to + 50°C
 - 3) Wire Harness for coil with Faston connector available as accessory

ACCESSORY

Wire Harness		
Model	Part Number	Cable Length [mm]
SQ-000000-090028	20805136301	1200
SQ-000000-090029	20805149201	2000

SHF SERIES 4 WAY REVERSING VALVE

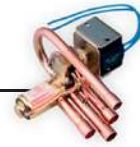

DIMENSIONS - COILS

Coils with Lead Wires (SQ-A25 Series)

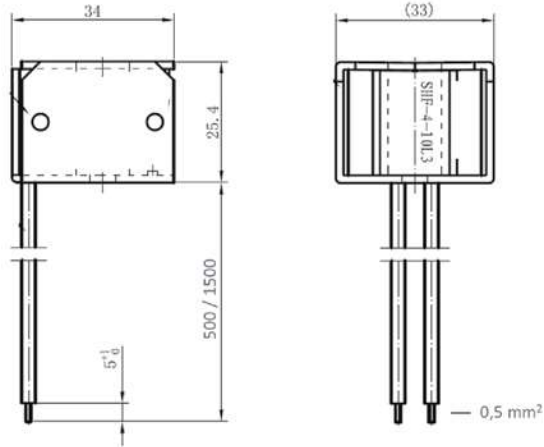

Coils with Spade Connections (SQ-A47)

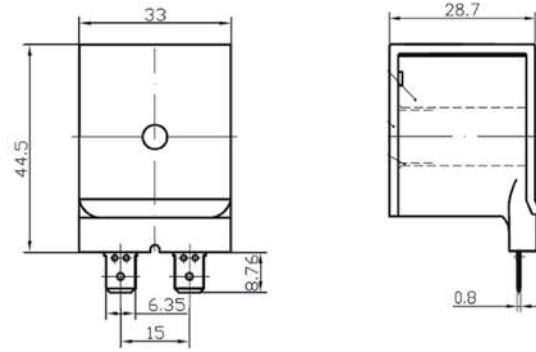

Wire Harness (SQ-000000-0900xx)

